

CONVEYORS

SOLUTIONS FOR EVERY APPLICATION



Expertise & Service



BEARINGS · POWER TRANSMISSION
ENGINEERED SOLUTIONS

www.bergab.ru

Берг АБ skf@bergab.ru Тел.(495)-228-06-21, факс (495) 223-3071

Australia's largest distributor of bearings, power transmission and engineered solutions

SPECIFIC SOLUTIONS

FOR EVERY CONVEYOR APPLICATION



Shaft-Hub
Locking Connection

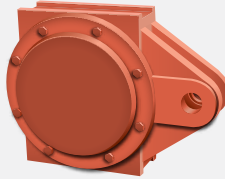

Take-Up Housing



ISN Housing

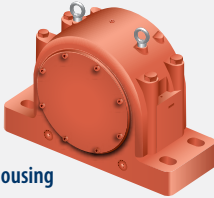

SD Plummer Block Housing



Wire Rope Sheave

1 TAIL PULLEY END

- **Spherical Roller Bearings:** NTN, FAG
- **Hydraulic Adapter Sleeve:** CBC, FAG
- **Split Roller Bearing:** Cooper, FAG
- **Conveyor Pulley Bearing Housings:** SSND, SDD, CSDD series
- **Take-Up Bearing Housing:** THM, TU series
- **Dead Shaft Pulley Bearing Housings & Covers:** CFCN series
- **ISN Mounted Bearing Housing:** Dodge
- **Insert Bearing Unit:** NTN, FAG
- **Scorpion Seal:** housing heavy duty seal
- **Shaft-Hub Locking Connections:** MAV
- **Wire Rope Sheaves:** CBC
- **Bearing Monitoring:** Vibration, temperature & grease
- **Installation & Alignment**
- **Project Management Services**

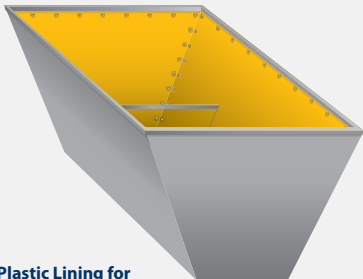

Plastic Lining for
Chutes & Hoppers

2 MAINTENANCE PRODUCTS

- **Plastic Liners for Chutes & Hoppers**
- **Hydraulic Nut & Pump Hire for Bearing Installation**
- **Anti-seize, Rubber Repair, Thread sealants, Thread Lockers & Retaining Compounds:** Loctite
- **Lubrication Delivery Systems, Single Point Lubricators:** Alemlube, Memolube, Perma
- **Sealants:** Dow Corning, Z-Seal, Loctite

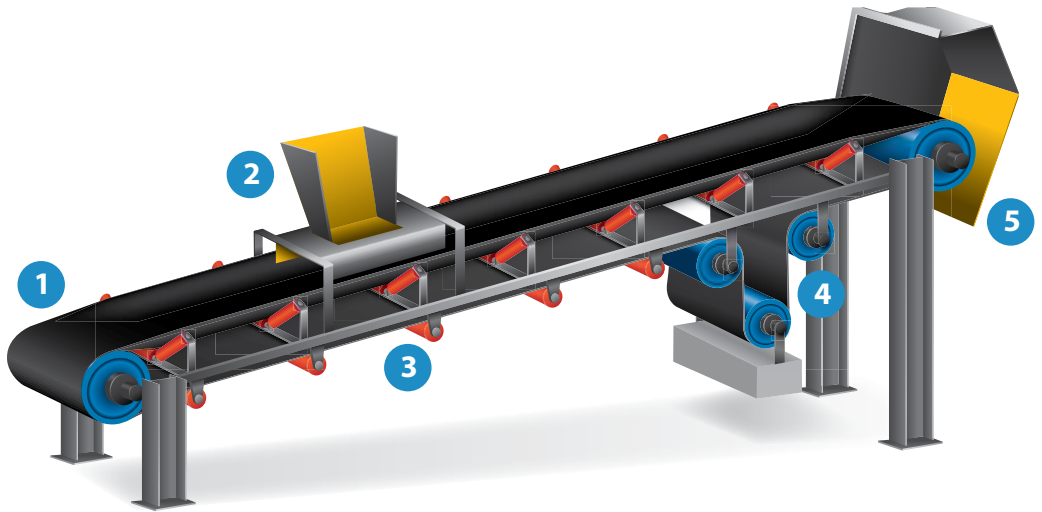

3 IDLER ROLLERS

- **Deep Groove Ball Bearings:** NTN, FAG
- **Low Torque Sealed Idler Bearings:** NTN
- **Bearing Retaining Circlips**
- **Rotary Seals & V-Labs**

4 SNUB, BEND & TAKE UP PULLEYS

- **Spherical Roller Bearings:** NTN, SNR, FAG
- **Hydraulic Adapter Sleeve:** CBC, FAG
- **Split Roller Bearing:** Cooper, FAG
- **Conveyor Pulley Bearing Housings:** SSND, SDD, CSDD series
- **Scorpion Seal:** housing heavy duty seal
- **Dead Shaft Pulley Bearing Housings & Covers:** CFCN series
- **ISN Mounted Bearing Housing:** Dodge
- **Wide Inner Ring Pillow Block & Bearing Insert:** NTN, FAG
- **Shaft-Hub Locking Connections:** MAV

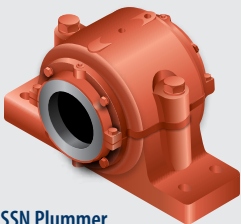

SSN Plummer
Block Housing

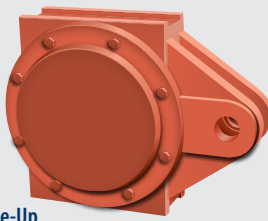

Take-Up
Housing

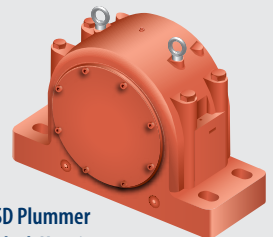

SD Plummer
Block Housing

5 DRIVE PULLEY END

SSN Plummer
Block Housing

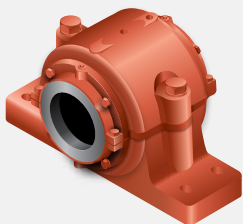

Split Bearing
Housing

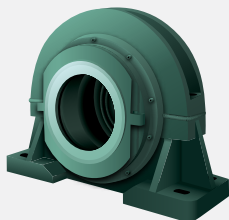

Shaft-Hub Locking
Connection

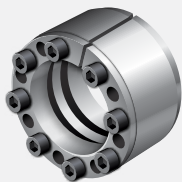

CSD Plummer
Block Housing

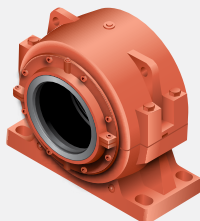

Motorised Torque Arm

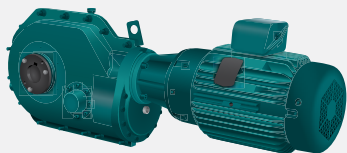

Drive Train
Setup

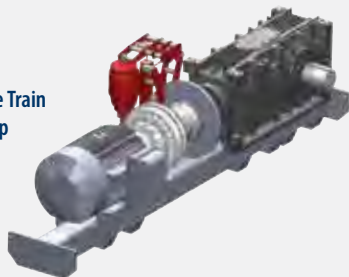

- **Spherical Roller Bearings:** NTN, FAG
- **Hydraulic Adapter Sleeve:** CBC, FAG
- **Split Roller Bearing & Housing:** Cooper, FAG
- **Conveyor Pulley Bearing Housings:** SSND, SDD, CSDD series
- **Scorpion Seal** – bearing housing heavy duty seal
- **ISN Mounted Bearing Housing:** Dodge
- **Insert Bearing Unit:** NTN, FAG
- **Drive Belts:** Gates, Fenner
- **Vee Belt Pulleys:** Martin, Fenner
- **Drive Pulley Guards** – custom built: CBC
- **Belt Tensioners:** Rosta
- **Shaft-Hub Locking Connections:** MAV
- **Shaft Couplings:** Falk, Martin, Fenner, Rexnord, David Brown
- **Coupling Guards** – custom built: CBC
- **Orange Peel Guards:** Falk
- **Electric Motors:** Baldor
- **Shaft Mounted Gear Reducers:** Dodge
- **Gear Reducers & Drives:** Falk, Motovario, Radicon
- **Fluid Couplings:** Transfluid
- **Low Speed Backstops:** Falk
- **Disc and Drum Brakes:** Transfluid
- **Bearing Monitoring** - Vibration, temperature, thermography & grease
- **Installation & Alignment**
- **Project Management Services**



SCHAEFFLER



FAG



MACHINED BASE REMEDIATION (MBR) correcting base alignment for conveyor pulley housings

CBC Australia has developed a specialised and efficient MBR procedure which corrects:

- bases that are not flat
- bases that are not co-planar
- bases that are not aligned to the conveyor centreline

MBR will correct any or all of these conditions with a single procedure. It takes just 5 hours, plus up to 6 hours grout drying time (temperature dependant). The procedure is carried out without machining, hot work or site power.

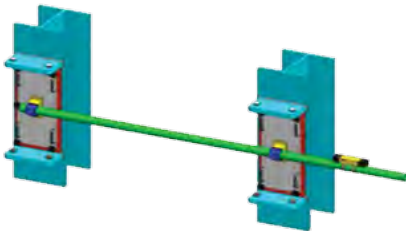



CBC Australia delivers premium quality product and highly specialised product support to industries with conveyor operations.

We are your all in one source for total bearings, power transmission and mechanical solutions, including:

- Purpose-designed bearings for all conveyors - fixed and mobile
- OEM approved bearings and power transmission components
- OEM approved seals
- Lubrication solutions
- Specialised products for repair and maintenance solutions

In addition to premium quality and OEM approved products, CBC Australia delivers a range of value added Engineering Services, including:

- Standardisation and rationalisation - to eliminate duplication of products and implement standard specifications
- MBTU training program for the proper fitting and maintenance of pulley bearings and housings
- Standards for the installation of rotatable equipment
- Maintenance practices and standards for lubrication rates and condition monitoring
- Improvement and upgrade of housing design and sealing for wet, dusty or challenging environments
- Design innovations
- Pulley bearing relubrication specifications
- Pulley bearing housing base alignment remediation service
- Pulley bearing housing base shim kits
- Pulley bearing and housing installation service
- Vibration analysis
- Condition monitoring



BEARINGS • POWER TRANSMISSION
ENGINEERED SOLUTIONS

For further information, contact CBC Australia Pty Limited

NEW SOUTH WALES

2/2-4 Tasha Place
Kings Park NSW 2148
T 02 9672 1600
F 02 9672 1966

QUEENSLAND

865 Kingsford Smith Drive
Eagle Farm QLD 4009
T 07 3866 2100
F 07 3866 2175

WESTERN AUSTRALIA

387 Victoria Road
Malaga WA 6090
T 08 6363 8220
F 08 9249 2940

NEWCASTLE

4/585 Maitland Rd
Mayfield West NSW 2304
T 02 4968 4000
F 02 4968 4040

VICTORIA

174 Fairbairn Road
Sunshine West VIC 3020
T 03 9313 2000
F 03 9313 2094

CBC JAKARTA

T +62 21 2922 1400
F +62 21 2922 1499

CBC BALIKPAPAN

T +62 21 2922 1400
F +62 21 2922 1488

SOUTH AUSTRALIA

479-481 South Road
Regency Park SA 5010
T 08 8348 2100
F 08 8348 2188

NORTHERN TERRITORY

Unit 4/ Lot 1554 Stuart Hwy
Winnellie NT 0820
T 08 8984 3558
F 08 8984 4852

www.conbear.com

